

Table of contents

1 GENERAL 1
 1.1 Requirements 1
 1.2 Functions 1
 1.3 Signalling 1
2 PROGRAMMING 2
 2.1 Program transmitters 2
 2.2 Delete transmitters 4
 2.3 Set timer 6
 2.4 Set runtime 7
3 TROUBLESHOOTING 8
4 GENERAL INFORMATION 8

1 GENERAL

With the remote learning function POTA (Programming Over The Air), a receiver that has already been installed and is no longer accessible can be reprogrammed. This may be necessary, for example, if a receiver is mounted behind a cupboard, has been wellpapered over or is otherwise difficult to reach.

However, where possible, normal programming should always be used as it is easier to use!

1.1 REQUIREMENTS

In order to use the POTA remote learning function, the following requirements must be met:

POTA-capable receiver

You can find out whether a receiver supports the POTA function in the operating instructions for the respective receiver. POTA must be explicitly listed as "Coding" under "Technical Details".

POTA-capable transmitter

All Easywave transmitters involved in the programming process must have the POTA learning button PTx. If in doubt, check the operating instructions for the transmitter in question to see whether it has a PTx button.

2 PROGRAMMING

2.1 PROGRAM TRANSMITTERS

POTA receivers can be put into programming mode with an already programmed Easywave transmitter with PTx button. Once the receiver is in POTA programming mode, new transmitters can be programmed or the operating mode of already programmed transmitters can be changed (see page 2 "POTA programming mode").

The PTx learning button is usually located on the back of the circuit board of the respective transmitter:

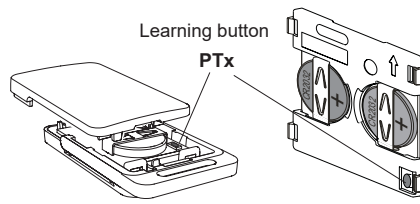

1.2 FUNCTIONS

Program transmitters

POTA-capable receivers can be put into programming mode via radio in order to learn additional transmitters or to change the operating mode of transmitters that have already been learned. All operating modes available in the receiver can be used (see page 2 "Program transmitters").

Delete transmitters

The delete mode of POTA-capable receivers can be activated by transmitters that have already been programmed. It is then possible to delete transmitters that have already been programmed from the receiver. The transmitter to be deleted must be available (see page 4 "Delete transmitters specifically").

Reset receivers (RESET)

To delete all transmission codes from a receiver, RESET using POTA is also available. This deletes all transmitters, including the triggering transmitter, from the receiver and resets all settings to the factory defaults (see page 5 "Reset receiver").

Set timer

Setting the timer length for receivers with the corresponding TIMER function is also possible using POTA (see page 6 "Set timer").

Set runtime

For receivers with adjustable motor running time, this function can also be used via POTA (s. page 7 "Set runtime").

1.3 SIGNALLING

Since POTA is primarily used when the receiver is no longer accessible, the individual programming steps are signalled by switching the respective receiver output or the connected electrical consumer.



During programming, multiple switching operations may occur in a short period of time! Make sure that the connected consumer is not damaged as a result! Before you continue with the next programming step, wait until the end of the respective signal!

Depending on the receiver variant, the signalling is different:

Switching receivers

The output/consumer is switched ON for the specified time and then OFF again.

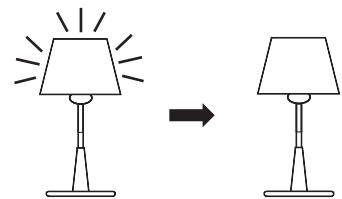

Motor receivers

The connected roller shutter is moved briefly in the OPEN and CLOSE directions one after the other for the specified time and then STOPS again.

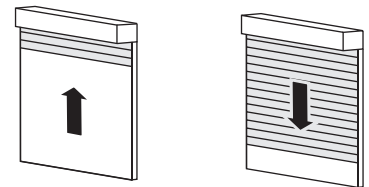

Regardless of how the programming mode is triggered, the following points must be observed when programming with POTA:

1. Pay attention to the timings / pauses / time-outs specified in the programming tables! If in doubt, use a stopwatch!
2. Always wait for the specified acknowledgements (e.g. flashing LEDs, switching outputs) before continuing with the next programming step!
3. There must be a maximum of 5 seconds between two button presses on the transmitter, otherwise the POTA mode will be terminated.
4. During POTA programming, only POTA telegrams are accepted. Normal radio telegrams / switching commands from Easywave transmitters are ignored by the receiver during this time!
5. If POTA programming was started with a transmitter button, it must be continued with exactly that button. As soon as another button on the transmitter is pressed, the POTA mode is ended.

POTA programming mode

The POTA programming mode allows a transmitter to be programmed into any operating mode (BA) of the receiver. The first programming of a transmitter always takes place in the first programming level of this operating mode.



If a transmitter is to be programmed into the second programming level, it must be programmed into the desired operating mode twice in succession.

For two-channel receivers, the second programming level corresponds to the second output.

If a transmitter that has already been programmed is programmed again in a different operating mode, the previous operating mode is overwritten with the newly selected one.

Which operating mode is located in positions BA1 to BA3 on the respective programming levels depends on the specific receiver and must be taken from the associated operating instructions. The sequence is always identical to conventional programming.

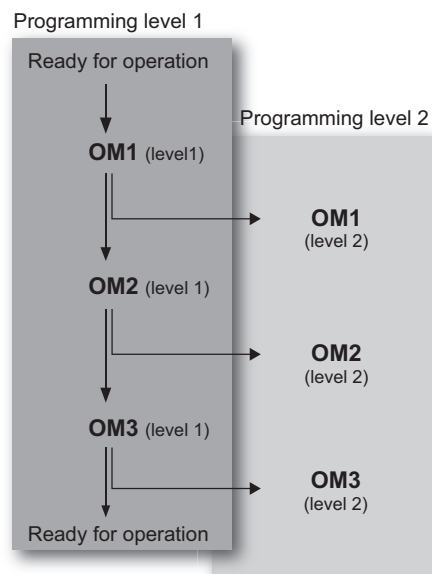

Operation [Press button]	Reaction transmitter	Reaction receiver
① PTx learning button of a programmed transmitter 1x briefly	Transmitter is in POTA mode for 5 seconds LED flashes	
② Transmitter button Tx of the programmed transmitter 1x briefly within 5 seconds	POTA telegram is sent LED flashes	Learning mode OM1 active for 30 s Output switches 1 second
2x briefly within 5 seconds	POTA telegram is sent LED flashes	Learning mode OM2 active for 30 s Output switches 1 second
3x briefly within 5 seconds	POTA telegram is sent LED flashes	Learning mode OM3 active for 30 s Output switches 1 second
4x briefly within 5 seconds	POTA mode is terminated LED OFF	Abort Programming mode ended Output switches 1 second
③ Programming button PTx of the transmitter to be programmed 1x briefly within 30 seconds	Transmitter is in POTA mode for 5 seconds LED flashes	
④ Transmitter button Tx of the transmitter to be programmed 1x briefly within 5 seconds	Learning telegram is sent After 5 seconds the POTA mode is cancelled	Output switches 3 second Transmission code learned Operating mode

Change own operating mode / programming level

A transmitter can also change its own operating mode by reprogramming it again into the desired operating mode. In this case, the programmed transmitter and the transmitter to be programmed are identical. After step ②/ after selecting the desired operating mode, a pause of at least 5 seconds is all that is required. This causes the already programmed transmitter to leave POTA mode and can then restart it in order to reprogram itself or change its operating mode. This procedure can also be used to change the programming level.

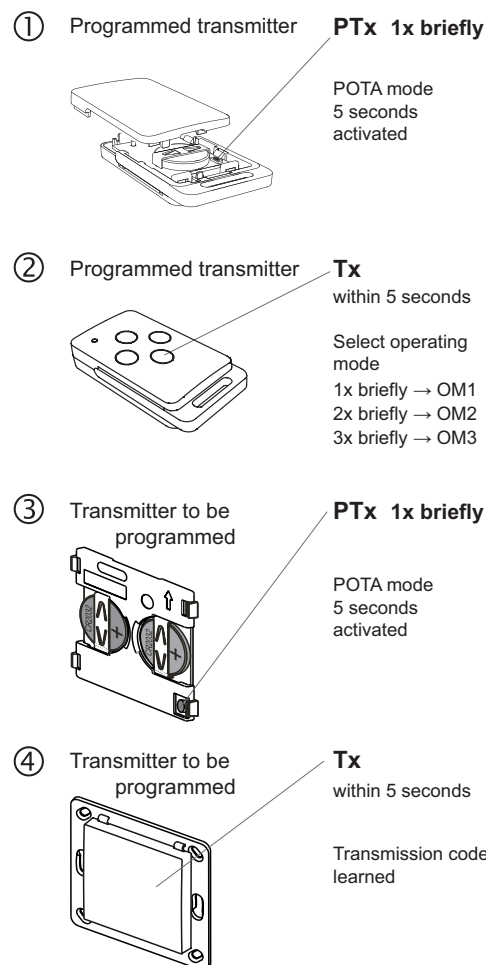

2 PROGRAMMING

2.1 PROGRAM TRANSMITTERS

Backup programming mode

If no programmed Easywave transmitter is available, POTA receivers can be put into POTA programming mode by interrupting the power supply five times for 30 seconds. For two-channel receivers (e.g. RCJ34), programming mode for the second channel can be started by interrupting the power supply a sixth time. The power interruptions must occur within 60 seconds, otherwise the counter is reset.

As soon as the backup programming mode is activated, the next transmitter that sends a POTA learning telegram within 30 seconds is programmed in the OM1 operating mode. The operating mode of the transmitter can then be changed (see page 2 "POTA programming mode").



Make sure that only the power supply to the desired receiver is interrupted! Otherwise, several receivers may be in backup programming mode at the same time!

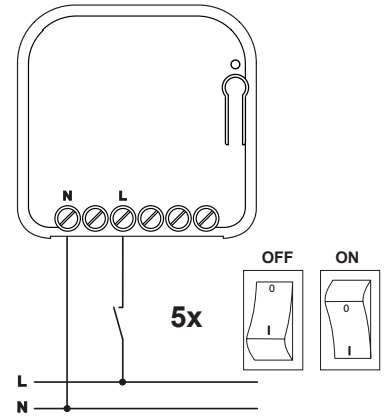

Safety notice

If work on the electrical system is necessary for programming, this may only be carried out by a qualified electrician.



Operation [Press button]	Reaction transmitter	Reaction receiver
① Voltage interruption OFF/ON 5x (6x) within 60 seconds		Backup learning mode activated for 30 seconds
② Learning button PTx of the transmitter to be programmed 1x briefly within 30 seconds	Transmitter is in POTA mode for 5 seconds LED flashes	
③ Transmitter button Tx of the transmitter to be programmed 1x briefly within 5 seconds	Learning telegram is sent After 5 seconds the POTA mode is terminated	Transmission code programmed in OM1 Output switches 3 second Operating mode



If the receiver's memory is full (usually at 32 programmed transmitters), it will be completely erased during the programming process by interrupting the power supply! The receiver will then only respond to the transmitter that has just been programmed. All other transmitters may need to be programmed again! All other settings (timer, runtimes, etc.) will remain the same.

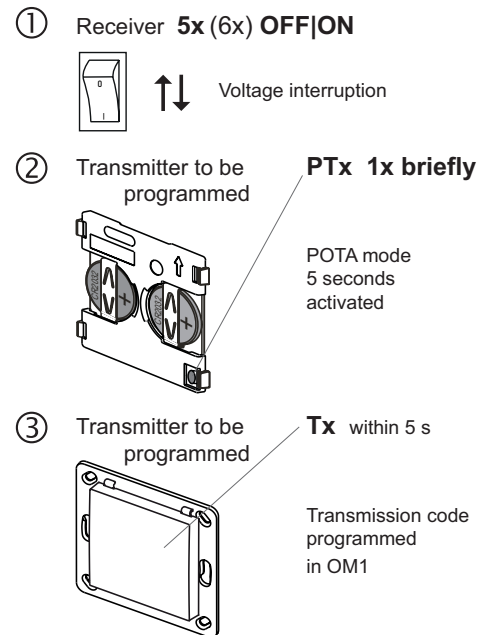

2.2 DELETE TRANSMITTERS

Delete transmitters specifically

Receivers can be put into delete mode using POTA. As soon as delete mode is active, the next Easywave telegram received from a programmed transmitter is deleted from the receiver's memory. Delete mode ends afterwards, or automatically after 30 seconds.



For two-channel receivers, the delete mode is only activated for the channel in which the transmitter is also programmed. If the transmitter is programmed in both channels, the delete mode is also activated in both channels.

If the transmitter to be deleted is programmed in two channels of a receiver, it will only be deleted from both channels if both channels are in delete mode.

Operation [Press button]	Reaction transmitter	Reaction receiver
<p>① PTx learning button of a programmed transmitter</p> <p>1x briefly</p>	<p>Transmitter is in POTA mode for 5 seconds</p> <p>LED flashes</p>	
<p>② Transmitter button Tx of the programmed transmitter</p> <p>1x long >5s within 5 seconds</p>	<p>Delete telegram is sent</p> <p>LED turns off after releasing the transmitter button</p>	<p>Delete mode active for 30 sec.</p> <p>Output switches 1 second</p>
<p>③ Transmitter button Tx of the transmitter to be deleted</p> <p>1x briefly within 30 seconds</p>	<p>Easywave telegram is sent</p>	<p>Received transmitter was deleted</p> <p>Output switches 3 seconds</p> <p>Operating mode</p>

 **A transmitter cannot delete itself!**
 This means that the last transmitter is always saved to ensure, that the programming mode of the receiver can be activated.
 To delete all transmitters from a receiver using POTA, perform a reset.

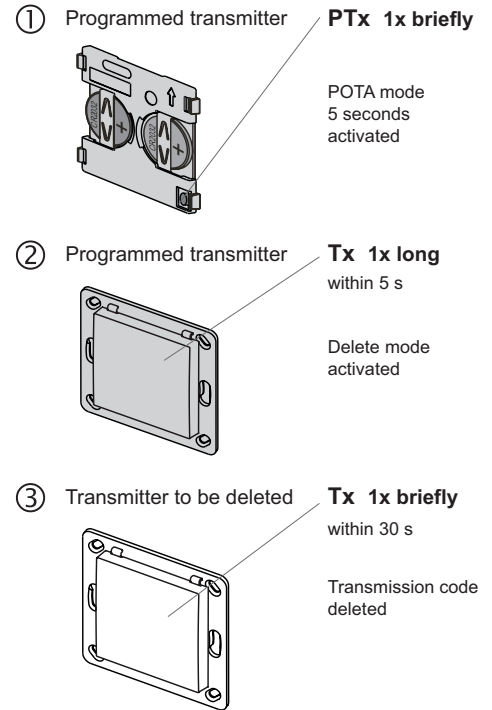

Reset receiver (RESET)

To delete all programmed transmitters of a receiver and restore the factory settings, a reset can be carried out using POTA. This resets all settings to the factory defaults.



For two-channel receivers, the reset occurs for both channels, even if the transmitter is only programmed into one channel.

Operation [Press button]	Reaction transmitter	Reaction receiver
<p>① PTx learning button of a programmed transmitter</p> <p>1x long >5s</p>	<p>Transmitter is in RESET mode for 5 seconds</p> <p>LED flashes quickly</p>	
<p>② Transmitter button Tx of the programmed transmitter</p> <p>1x long >5s within 5 seconds</p>	<p>RESET telegram is sent</p> <p>LED turns off</p>	<p>RESET carried out</p> <p>Output switches 3 seconds</p> <p>Operating mode</p>



After the reset, the programming mode can only be activated on the device or by interrupting the power supply (see page 3 “Backup programming mode”)!

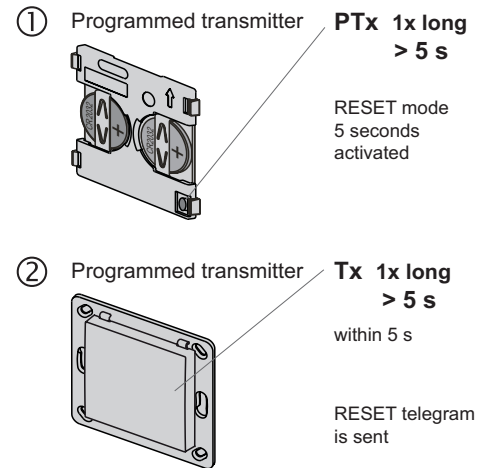

2.3 SET TIMER

Generally

The TIMER length can be set for receivers with TIMER mode using POTA. A base time of max. 30 seconds is measured and then multiplied by the selected multiplier. The same maximum values and multipliers apply as when setting directly on the device (see the receiver's operating instructions).

Time measurement

The timing in step 3 stops automatically after 30 seconds (maximum value), but it does not automatically proceed to step 4! After reaching the maximum timing value (30 seconds), you have another 30 seconds to start step 4 (multiplier selection).

If this time is exceeded, the TIMER setting will be aborted without making any changes.

Multiplier selection

The multiplier is selected by pressing the transmitter button several times. There are six multipliers available (1x to 3,600x).

If the transmitter button is pressed more than six times during this step, the timer setting will be cancelled without making any changes.

Once the desired multiplier is selected, do not press any button for 5 seconds to complete the TIMER setting.

Operation [Press button]	Reaction transmitter	Reaction receiver
① PTx learning button of a programmed transmitter 2x briefly	Transmitter is in TIMER mode for 5 seconds LED flashes twice	
② Transmitter button Tx of the programmed transmitter 1x briefly within 5 seconds	TIMER telegram is sent	Time measurement starts (max. 30 s) Output switches 1 second
③ Transmitter button Tx of the programmed transmitter 1x briefly within 60 seconds	Easywave telegram is sent	Timing stops Output switches 1 second Multiplier = 1
2x briefly within 5 seconds	Easywave telegram is sent	Output switches 1 second Multiplier = 10
3x briefly within 5 seconds	Easywave telegram is sent	Output switches 1 second Multiplier = 60
4x briefly within 5 seconds	Easywave telegram is sent	Output switches 1 second Multiplier = 600
5x briefly within 5 seconds	Easywave telegram is sent	Output switches 1 second Multiplier = 1,800
6x briefly within 5 seconds	Easywave telegram is sent	Output switches 1 second Multiplier = 3,600
④ Wait 5 seconds		New TIMER time set (measured time x multiplier) Output switches 3 seconds Operating mode

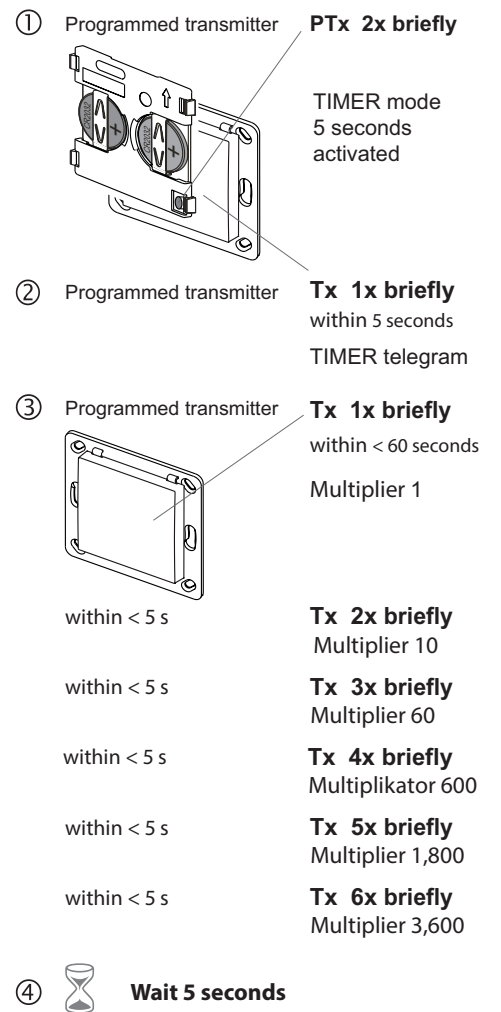

The timer setting must be completed with the same transmitter and the same transmitter button with which it was started!

2 PROGRAMMING

2.4 SET RUNTIME

Generally

Receivers for motor control have adjustable runtimes for both directions of travel. The runtime can be set using POTA, similar to programming on the receiver. The runtime measurement is done when the motor is connected and ready for operation and involves moving to the end positions several times (similar to the runtime setting on the device).

Runtime measurement

The roller shutter can be moved to the end positions as often as you like. For each direction of travel, the last measured runtime between two STOP commands is always saved. To complete the runtime measurement, wait 30 seconds while the roller shutter STOPS. After 30 seconds have elapsed, the roller shutter signals the successful setting by moving in the UP and DOWN directions for three seconds.

Notes

If the runtime measurement was started with a transmitter, it must also be completed with exactly that transmitter!

The maximum adjustable runtime is approximately 1.8 hours.

The more precisely you send the STOP command when reaching the end positions, the more precisely the positions can be reached later. The runtime measurement is carried out in the operating mode in which the transmitter is programmed (1-button, 2-button or 3-button operation).

Operation [Press button]	Reaction transmitter	Reaction receiver
① PTx learning button of a programmed transmitter 2x briefly	Transmitter is in TIMER mode for 5 seconds LED flashes twice	
② Transmitter button Tx of the programmed transmitter 1x briefly within 5 seconds	TIMER telegram is sent	Runtime measurement starts Output switches UP/DOWN for 1 s
③ Transmitter buttons Tx of the programmed transmitter UP 1x briefly within <30 seconds	Easywave telegram is sent	Roller shutter moves to upper end position
STOP 1x briefly	Easywave telegram is sent	Roller shutter stops
DOWN 1x briefly within <30 seconds	Easywave telegram is sent	Roller shutter moves to lower end position
STOP 1x briefly	Easywave telegram is sent	Roller shutter stops
UP 1x briefly within <30 seconds	Easywave telegram is sent	Roller shutter moves to upper end position
STOP 1x briefly	Easywave telegram is sent	Roller shutter stops
④ Wait 30 seconds while roller shutter STOPS		New runtime set (last measured time for each direction) Output switches UP/DOWN for 3 s Operating mode

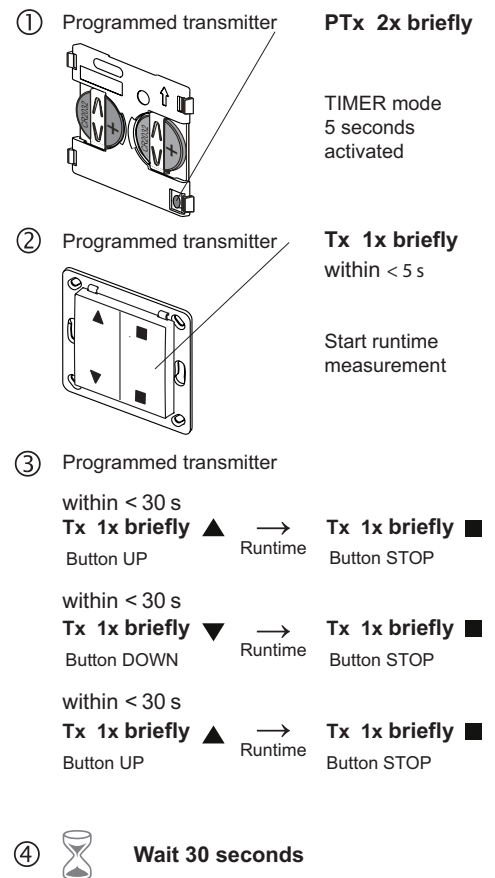

The runtime setting must be completed with the same transmitter it was started with!

3 TROUBLESHOOTING

No reaction at the receiver output to POTA telegrams:	Receiver is not POTA compatible	Consult the operating instructions.
	No consumer connected to the output / consumer defective?	Check connected consumer and replace if necessary.
	Different buttons on the transmitter are pressed	Wait 30 seconds and start programming again.
Backup programming mode does not start:	The receiver's transmitter memory is full.	Delete a transmitter from the receiver or perform a RESET if necessary.
	More than 60 seconds between the five voltage interruptions	Wait 60 seconds and start again. Pay attention to the time limits.
	Voltage not completely interrupted (residual voltage from power supplies, capacitors, etc.)	Increase the time of the power interruption until the battery is completely discharged. The receiver must not be supplied with power for more than 60 seconds in total during the five power interruptions. The duration of the power outage is irrelevant.
	Receiver is not POTA compatible	Consult the operating instructions.

4 GENERAL INFORMATION

Safety notice

If work on the electrical system is necessary for programming, this may only be carried out by a qualified electrician.



Customer service

If you need further support, please contact our customer service.

ELDAT EaS GmbH

Schmiedestraße 2
15745 Wildau
Germany
Phone: +49 3375 9037-310
Internet: www.eldat.de
E-mail: info@eldat.de